

Data-Sheet-Motorized Vacuum Capacitor CKTBM250/15/94N1 (I)

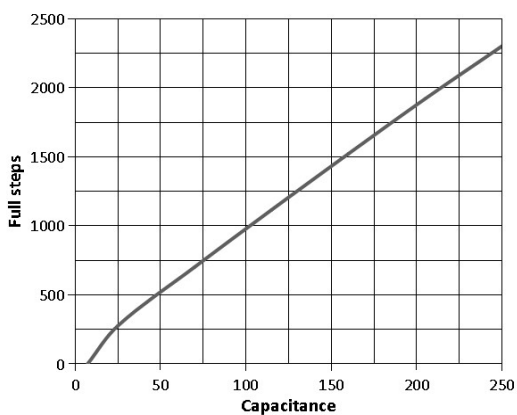

Specification	
Capacity C_{max} (nominal)	250pF
Capacity C_{min} (nominal)	25pF
Voltage (Peak Test U_{pt} /Peak Working U_{pw})	15kVp/9kVp
Capacity tolerance (linear Range)	$\pm 1\%$
Max. Current I_{max} at 13.56MHz with	94Arms
Conduction Cooling	20W
Self Inductance	$\leq 10nH$
Capacitance per 100 steps	10.7pF
Net Weight	1.2kg
Ground to variable end capacitance	$\leq 5pF$

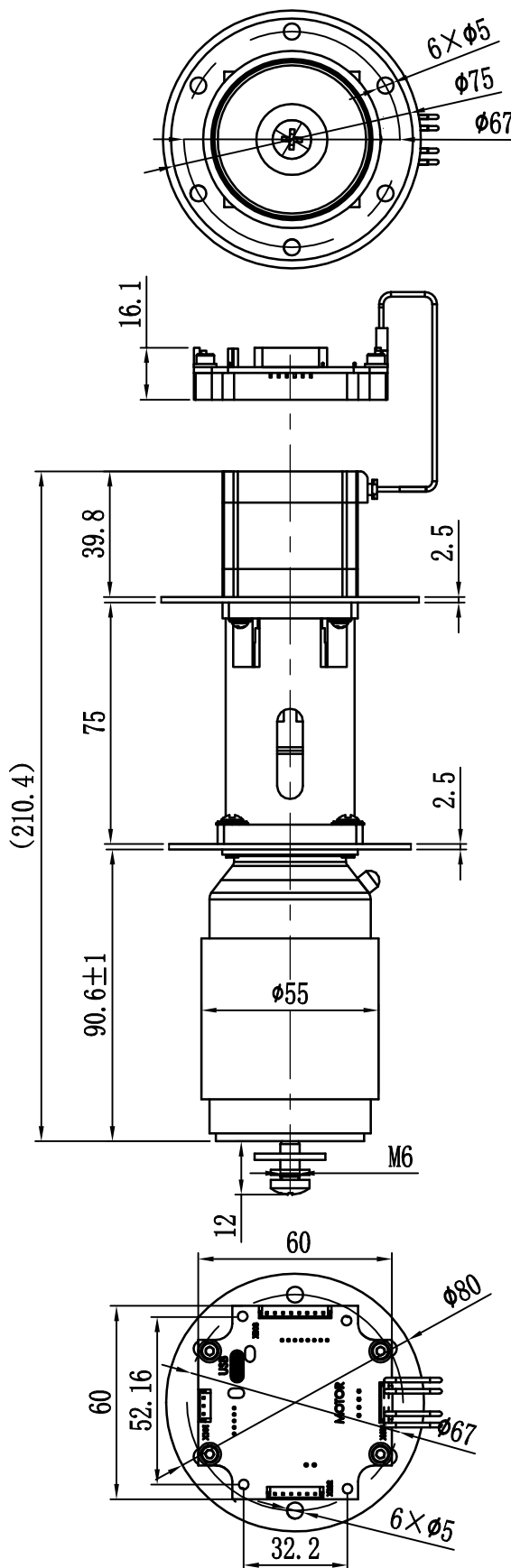

I_{max} at 25 °C ambient and 125 °C surface temp.
for convection and conduction (20w) cooling

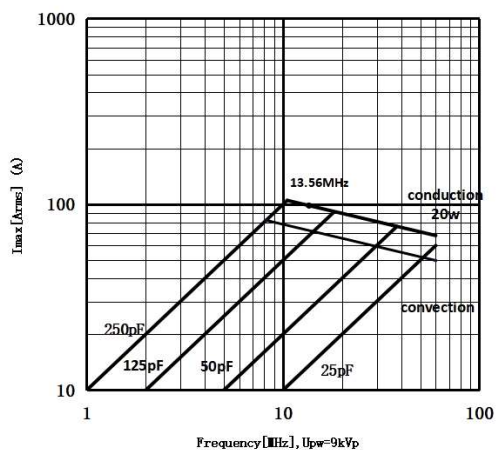

UNLESS OTHERWISE SPECIFIED:

$\leq 30: \pm 0.5$ $30 \sim 400: \pm 1.2$ $\geq 400: \pm 2.5$ $\angle \pm 1^\circ$

Address: ST28 Xihu Road, Kunshan, Jiangsu Province, China
TEL: +86 (512) 36872110

Rev: 10

Web: www.glvac.com
FAX: +86 (512) 36872122

Page 1/3 Issue: 28-Aug-2023

E-mail: e-sales@glvac.cn
Zip Code: 215333

Data-Sheet-Motorized Vacuum Capacitor CKTBM250/15/94N1 (I)



FullSteps	Nominal Capacitance[pF]	Tolerance
0	7.2	±1pF
277	25.0	±1pF
500	48.5	±1pF
1000	103.0	1%
1500	157.0	1%
2000	214.8	1%
2304	250.8	1%

Mechanical stop Cmin. at <25pF
Mechanical stop Cmax. at >250pF

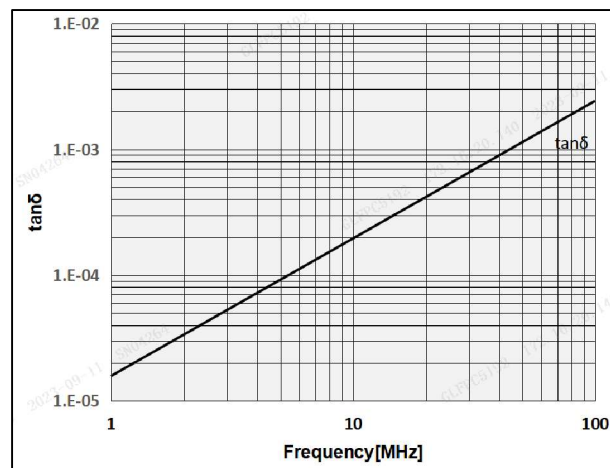
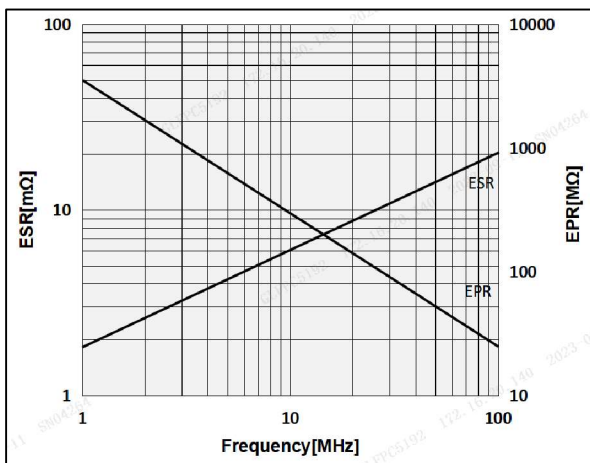
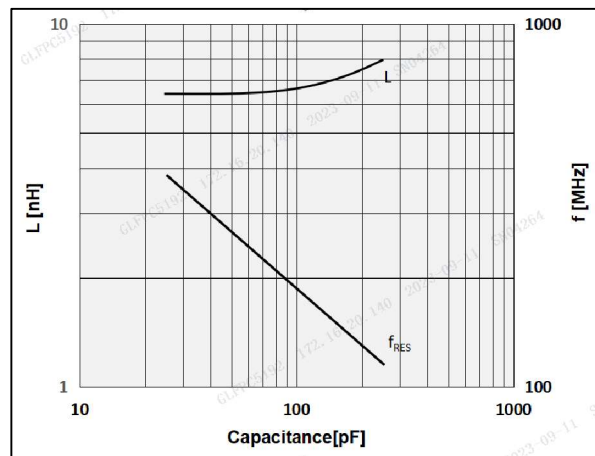

General handling information for the integrated drive

When installing or removing the integrated drive, extreme care must be taken to avoid damage to the body of the integrated drive. Although the integrated drive looks very rugged from the outside, it must be remembered that, due to the brazing process used to join ceramic and copper, the copper is in a soft, annealed condition and is therefore highly avoided. Use existing threads and holes for fixation. For all integrated drives, we recommend that one side be mounted non-rigid to prevent excessive thermomechanical and external forces from acting on the capacitor.

UNLESS OTHERWISE SPECIFIED:

≤30: ±0.5 30~400: ±1.2 ≥400: ±2.5 ∠ ±1°

Address: ST28 Xihu Road, Kunshan, Jiangsu Province, China
TEL: +86 (512) 36872110

Rev: 10

Web: www.glvac.com
FAX: +86 (512) 36872122

Page 2/3 Issue: 28-Aug-2023

E-mail: e-sales@glvac.com
Zip Code: 215333

Data-Sheet-Motorized Vacuum Capacitor
CKTBM250/15/94N1 (I)



Drive Specification	
Tunning speed(end to end)	<3s
Backlash	≤2
Operation mode	Bipolar
Nr. of phases	2
Rated phase current(RMS)	1.5A
Supply voltage(DC)	24V
Full step angle	1.8°

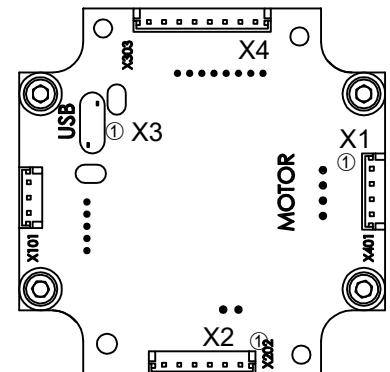

X1 Motor			
Pin1	OB2	Blue	B-
Pin2	OB1	Red	B
Pin3	OA2	Green	A-
Pin4	OA1	Black	A

X2 Power and Communication	
Pin1	0V(GND)
Pin2	9V—30V(VDC)
Pin3	
Pin4	
Pin5	RS232_TXD
Pin6	RS232_RXD

X3 Mini-USB		
Pin1	USB_GND	GND
Pin2	USB_5V	USB Power 5V
Pin3	Data-	USB Data-
Pin4	Data+	USB Data+

X4 is not used